

REVIEWER FORM

- The paper **MUST** be reviewed with the same degree of thoroughness as any other paper published in IEEE journals in terms of technical merit, and in terms of IEEE format.
- Since the majority of the papers will be created using a computer, the reviewer should not hesitate to require the author to make changes so that the paper is raised to IEEE technical merit standards.
- Please complete the Reviewer's Report Form given below and on the reverse side of this page. You may also make comments directly on the review copy of the paper. **Please use a BLACK pen as RED ink may not fax properly.**
- This form and the paper with your revisions (if needed) must be returned to the appropriate Technical Editor **NO LATER THAN OCTOBER 21, 2005.**
- Please reference the enclosed listing or the conference web site (mt-19.ge.infn.it) to obtain the Technical Editors' contact information and the sessions assigned to them to ensure that you submit your Reviewer's Report Form and comments to the appropriate editor. **PLEASE FAX OR EMAIL THE COMPLETED REVIEWER FORM AND ANY ADDITIONAL COMMENTS TO THE TECHNICAL EDITOR. DO NOT SEND VIA MAIL.**

MT-19 REVIEWER'S REPORT

Paper Number MOM30R4 Paper Title Opposite-field Septum Magnet System for the
First Author I. Sakai J-PARC Main Ring Injection

IEEE Format of the Paper:

1. Is the paper formatted according to the IEEE formatting standards that were included in the Instructions to Authors for the preparation of their manuscript? Yes No If no, please circle the items that need to be corrected.
 - Number of Pages (4 oral/poster, 6 invited).
 - Paper Size (8.5" x 11").
 - Columns - fully justified.
 - Column width - 88 mm (3.45 in.).
 - Spacing between columns - 5 mm (0.2 in.).
 - Paragraph indentation - 3.5 mm (0.14 in.).
 - Paper spacing needs to be adjusted between text and section headings, tables, etc. to obtain equal lengths for adjacent columns.
 - Paper spacing adjusted on last page to obtain equal column lengths.
 - Hyphenation.
 - Correct font (Times New Roman or similar).
 - Use of appropriate capitalization for the words within the title.
 - Use of appropriate abbreviations and acronyms.
 - Use of correct format for tables and figures.
 - Use of correct format for appendixes and acknowledgments.
 - Use of correct format for references.
 - Spelling corrections necessary.

Technical Merit of the Paper:

1. Is the paper's subject matter about Magnet Technology? Yes No If no, please explain further in the Reviewer Comments section on the reverse side of this form.
2. Is the author's meaning clear and is the paper arranged logically? Yes No If no, please use BLACK ink on the review copy of the paper to indicate the sections that require revisions.
3. Does the paper contain errors in fact? Yes No If yes, please use BLACK ink on the review copy of the paper to indicate the errors. Additional remarks should be recorded in the Reviewer Comments section on the reverse side of this form.
4. The paper technical merit is: Outstanding Above Average Average Below Average
Contains No Technical Merit

DO NOT WRITE REVIEWER COMMENTS BELOW THE LINE

5. The paper originality: New theory, data or technique Y Similar to work done by others _____
 A review of previous work by the same author(s) _____
6. As far as you know, has this paper been published before? Yes _____ No X
 If yes, where was it previously published. _____
7. Does the title properly describe the paper? Yes X No _____
 Does the abstract describe the contents of the paper? Yes X No _____
 Does the summary express the main points of the paper? Yes X No _____
8. Are all of the tables and figures necessary for a good technical understanding of the paper? Yes X No _____
 Are the tables and figures clear? Yes _____ No X → Font sizes on figures are small & difficult to read.
 Are the figure and table captions clear? Yes _____ No X → Fig. 1 Caption & number is missing
9. Does the author place the paper in proper context by the use of appropriate references? Yes _____ No X
 If no, please explain. Additional remarks should be recorded in the Reviewer Comments section of this form.
10. Is the paper written in correct English? Yes _____ No X Please use BLACK ink to indicate any English errors on the review copy of the paper.

Recommendation:

- _____ Publish as is.
X Publish, revisions required. (See edits on paper and reviewer comments.)

_____ Reject. **INDICATE REASON FOR REJECTION.**

- _____ Not Magnet Technology. Suggestion for an alternate journal. _____
 _____ Lack of Technical Merit.
 _____ Not Original Work.
 _____ Work Published Previously.
 _____ Unsatisfactory English.

Reviewer Comments:

- ① I believe this is important and interesting work and it should be published. The paper, though needs further work to be presentable.
- ② My main complaint is the writing style is sloppy. The paper could greatly be improved by writing more concisely (less "wordy") and allowing ~~for~~ more room for the figures, which are small and difficult to read.
- ③ There are two places where the authors cite external source information but provide no references. These references should be included.
- ④ I was not able to print the paper from my computer. The pdf file required Japanese language support. I had to get a Japanese colleague in my building to print it.

DO NOT WRITE REVIEWER COMMENTS BELOW THE LINE
 PLEASE REMOVE THE REVIEWERS DETAILS BEFORE SENDING TO AUTHOR

Reviewer's Signature Kevin A. Brown

Name (Please Print) Kevin A. Brown

Telephone Number: 631-344-4409 FAX Number: 631-344-5954

E-mail: kbrown@bnl.gov

Opposite-field Septum Magnet System for the J-PARC Main Ring Injection

I. Sakai, K. Fan, Y. Arakaki, M. Tomizawa, Y. Mori, Y. Saitou, M. Uota, A. Nishikawa, R. Morigaki,

Abstract— The opposite-field septum magnet has been developed to realize a large-aperture, thin-septum magnet. The features of the system are a force-free structure, easy pulse excitation and cancellation of the leakage flux. This new design concept is being applied to the injection septum magnet for the J-PARC Main Ring proton synchrotron. The septum conductors are set inside of a vacuum chamber to eliminate the thickness of the vacuum-chamber walls and electric-insulation layers. The magnet cores and return coils are set outside of the vacuum chamber to reduce the out-gassing rate of the vacuum system. Finally, a larger beam aperture than the full acceptance of the ring can be obtained at the injection septum magnet for lower beam-loss injection..

Index Terms—Charged particle beams, magnet, septum

I. INTRODUCTION

The J-PARC main ring proton synchrotron (MR) is designed to accelerate 8.3×10^{13} protons (8 bunches) up to 50 GeV every 3.64 sec repetition. The injection energy is 3 GeV. The acceptance of the MR is designed to be 81π mm mrad in both the horizontal and vertical planes. The incoming beam emittance from the 3-GeV rapid cycling synchrotron (RCS) is shaped to 54π mm mrad in both the horizontal and vertical planes using a scraper and collimator system. High-intensity high-energy accelerators impose tight demands on the injection extraction septum magnets because of its large aperture and high magnetic field. Especially regarding the injection system, their large-size injection beam and a circulating beam, before adiabatic damping, must be separated in the limited length of the straight section. A thin structure, large aperture and high operating magnetic field septum magnet are required. To cope with these tight demands, a new design concept of the opposite-field septum magnet system has been invented [1].

In this paper we describe the structure of the opposite-field septum magnet system for the J-PARC MR injection and how to solve technical problems of the pulse-excited opposite-field septum magnet system.

II. INJECTION SYSTEM FOR THE J-PARC MAIN RING

A. Concept of the Opposite-field Septum Magnet

The concept of the opposite-field septum magnet system is

Manuscript received September 18, 2005.

I. Sakai, email izumi.sakai@kek.jp Fax +81-29-864-3182

shown in Fig. 1. The same grade of opposite magnetic field is produced both inside and outside of the septum. The electromagnetic force on the septum conductors is cancelled out by each other by opposite magnetic fields on both sides of the septum. The two septum conductors are arranged vertically to form a single line of septum conductors to form a thin septum coil.

The magnetic field of the circulating beam side is compensated by two sub-bending magnets set up-stream and down-stream of the opposite-field septum magnet. These three magnets are connected in series and excited by the same power supply for simultaneous excitation. The thin septum conductor will be available without any mechanical support, and pulse excitation for power saving becomes easier than that for the normal septum magnet. The leakage flux is cancelled out by each other and the beam-separation angle per magnet length is twice as large as that of the normal septum magnet with the same magnetic field. The two sub-bending magnets also enhance the injection angle. The thin septum makes it possible to obtain a sufficient aperture at the septum magnet

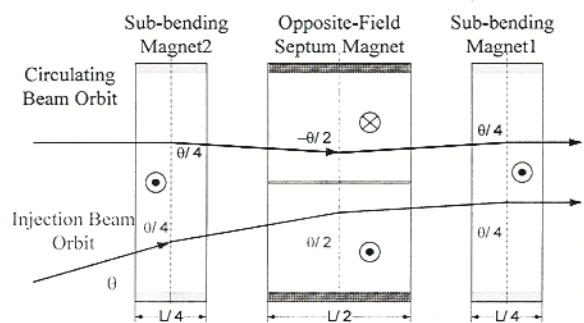

B. Outline of the Injection System

An outline of the injection system is shown in Fig. 2.

The injection system is composed of a high-field (1.36T) normal septum magnet, the opposite-field septum magnet system (0.60T) and 3 kicker magnets (0.065T), not shown in Fig.2. The parameters of the magnets for injection are given in Table 1. With the limited length of the straight section and the restriction of the kicker magnets, the bending angle of the septum magnet is required to be as large as possible to clear the yoke of the upstream quadrupole magnet. The opposite-field septum magnet has a thin structure (8 mm). The injection beam is shaped to 54π mm mrad by a collimator at the injection

Confusing & poorly written

mean is unclear not quantified

Type?

No Fig # a caption

Schematic would be better choice.

95% Normalized? Please state.

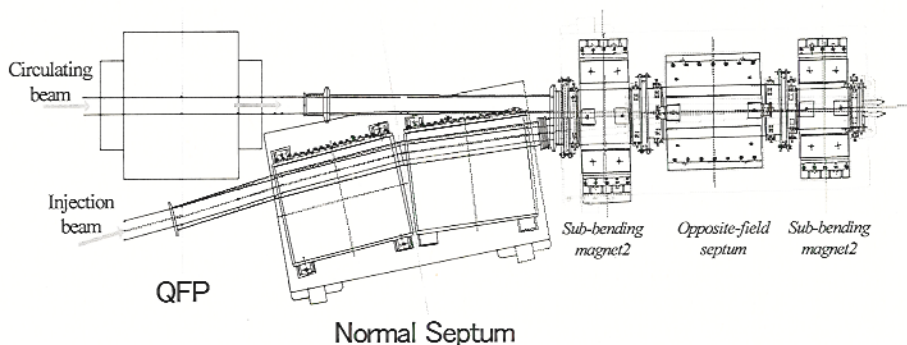

Fig.2 Outline of the injection system

beam line. The full acceptance of the injection beam line and the Main ring are designed to be more than 81π mm mrad, so as to clear the beam halo of the collimator. The aperture at the opposite-field septum magnet is designed to be 90π mm.mrad, which exceeds the minimum criterion of the full acceptance of the ring. The opposite-field septum magnet makes it possible to have a sufficient clearance at the injection point, and also makes the total injection system simple and compact by its high field and thin septum structure..

Table 1; Components of the injection magnets

Element	Gap (mm)	Length (mm)	B (T)	Angle (mrad)
Septum I	98	1800	1.48	191
Sub-bend 1	120	350	0.556	17
Septum II	120	700	0.556	34
Sub-bend 2	120	350	0.556	17
Kicker (x3)	100	800	0.1	7

III. TECHNICAL ASPECT OF THE OPPOSITE-FIELD SEPTUM MAGNET

A. Structure of the Opposite-Field Septum Magnet

A transverse cross-sectional view is shown in Fig. 3. As shown in Fig.1, twice as much as the return current must flow on the septum part. The two coils are arranged vertically to form a single line of septum conductors to form a thin septum.

A longitudinal cross-sectional view is shown in Fig. 4. In the septum conductor (copper) four stainless-steel cooling water pipes, which are gathered to one pipe at the end of the conductor, are sandwiched by the Hot Isostatic Pressing (HIP) technique.

The core of the magnet and the return coils are set outside of the vacuum chamber so as to decrease the out-gassing rate, and only the septum conductors are set inside of the vacuum chamber, which is made of alumina ceramic.

B. Waveform of Excitation current

Since the opposite-field septum magnet has a force-free structure, pulse excitation is easily acceptable to escape the problem of heat generation at the septum.

The thin septum structure is available because of pulse

possible or more precise winding would be better.

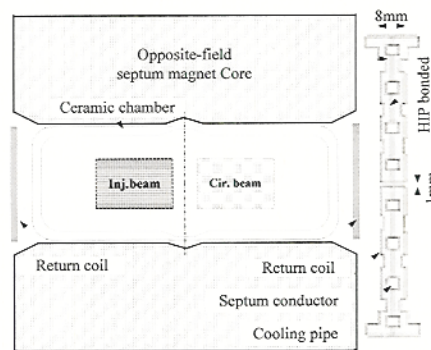

Fig.3 Transverse cross-section

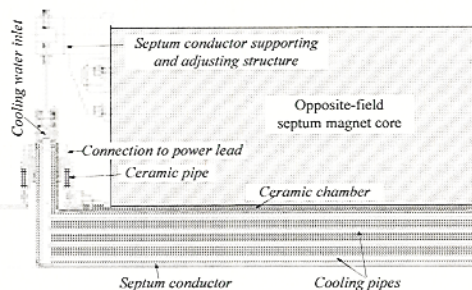

Fig. 4 Longitudinal cross-section (quarter part)

operation. To realize a thin septum, a short rectangular pulse is desirable for the excitation current to decrease the heat generation at the septum, but the short rise time requires high-voltage operation. For compatibility of power saving and low-voltage operation, a half sine wave, of which the width is 2.5 ms, is selected. The total inductance of the main septum magnet and sub-bending magnet is $5.3 \mu\text{H}$, and the total resistance is $0.221 \text{ m}\Omega$. The maximum excitation current is 53.5 kA for 0.556 T . The maximum operating voltage is 356 V .

winding could be improved

The injection septum magnets are required to operate at a period of $900 \text{ ns} \times 4$ repetition for the two bunches $\times 4$ repetition mode injection and the maximum repetition rate of 16 for the one bunch $\times 16$ repetition mode injection with a repetition cycle of 25 Hz of the 3-GeV RCS.

ref? for requirements

C. Power Supply Circuit

The injection system is designed to suppress emittance

growth by injection errors to be less than 2%. In this situation, the stability of the magnetic field is required to be less than 2×10^{-4} . The half sine wave is produced by an LC circuit, and the output current is enhanced by a pulse transformer near to the septum magnet. The output voltage of the power supply is fed back by a direct measurement of the excitation current.

IV. COMPENSATION OF ERROR FIELD

A. Criterion of Error Field

As shown in Fig. 1, the opposite-field septum magnet system is composed of the main septum magnet and two sub-bending magnets. The integrated magnetic field along the circulating beam axis is designed to be zero so as to suppress any closed-orbit distortion around the whole ring. The required criterion of the maximum closed-orbit distortion is less than 1mm. Under this assumption, the maximum error field along the circulating beam axis is less than 1×10^{-3} of the total injection kick angle of the opposite-field septum magnet system.

B. Mechanical Errors

The fabrication errors and the difference in the effective length will be compensated by a fine adjustment of the sub-bending magnets, which are initially designed to have a variable-gap structure, as shown in Fig. 6. The core is supported by an outer structure, of which the gap is adjustable by inserting several thicknesses of stainless-steel spacers. The ideal gap was obtained by trial and errors by changing the spacers while measuring the integrated field by long coil. Finally, the gap of the sub-bending is 129.5 mm versus 120 mm of the main septum magnet.

C. Eddy Current errors

After a fine adjustment of the magnet gap of the sub-bending magnet, the residual field errors are caused by eddy currents. Principally, in the opposite-field septum magnet system, the eddy-current fields of the individual magnets are cancelled out by each other. However, disproportion of the eddy-current with the different structures of the cores causes an error field along the circulating beam axis.

The integrated error fields caused by eddy current can be compensated by self-induced back-leg windings of the magnet, which adds a induced magnetic field of the same polarity of eddy current field on the core of a lower eddy-current field. In our case, the total eddy-current field of the sub-bending magnets is superior to that of the main septum magnet. Thus, we must set self-induced back-leg windings on the return yoke of the main septum magnet.

As shown in Fig. 5, the back-leg windings form a short circuit with septum conductors because it is hard to insert a back-leg coil between the return yoke and the ceramic vacuum chamber. The effect of this short bypass of the main septum conductor is negligible because the resistance of the septum conductor is 35 mΩ, on the other hand, the resistance of the bypass is about 72 mΩ, which is 2×10^3 -times larger than that

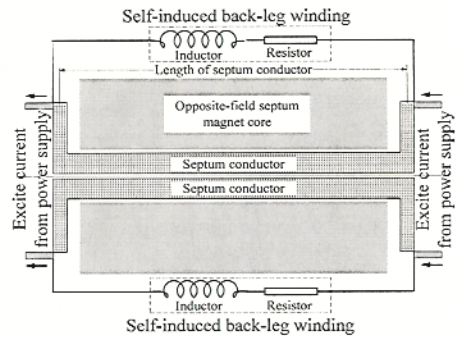

Fig. 5 Self-induced back-leg windings on the return yoke of the main septum magnet

of septum conductor. The back-leg windings include resistance and inductance to control the current and phase of the induced current, which produces an additional magnetic field to cancel the eddy current fields at the sub-bending magnet. After trial and errors, the value of the resistance and inductance were chosen to be 72mΩ and 12.7 μH, respectively. *rephrase*

The error field without any back-leg winding is about 1% of the total kick angle (68 mrad) of the septum magnet system, and after compensation with self-induced back-leg windings less than 0.05% has been achieved.

These compensation techniques using self-induced back-leg windings are applicable for other "dog-leg bump orbit" magnet systems. These compensation techniques have already been verified by experiments on the H⁻ injection bump magnets for the 500-MeV booster synchrotron in the KEK 12-GeVPS. *ref.?*

V. FIELD QUALITY

A. Conductor shape and field distribution

The detailed structures of the septum coils and magnet poles, including a ceramic vacuum chamber are shown in Fig. 3. The incoming beam and the circulating beam both have rectangular shapes. A uniform magnetic field distribution is required not only near the medium plain, but also at the vertical edge of the septum. To obtain a uniform magnetic field, the thickness of the ceramic vacuum chamber is a partially thin structure so as to approach the septum conductor to the pole surface as closely as possible. Nevertheless, the minimum gap between the septum coil and the magnet pole is 6 mm. These gaps and holes in the conductor disturb the uniformity of the magnetic field near to the septum. The cross section of the conductor is shaped so as to form a uniform distribution of the average current along the vertical axis of the septum conductor. The field distribution calculated by computer code "Poisson" is shown in Fig.6. *spell*

The required vertical aperture at the septum is ± 36 mm at the septum. The field distribution normalized by the value of the circulating beam center has been achieved to be less than 0.5% within an area of more than 6 mm far away from the surface of the septum. *uniformity?*

The vertical component B_y of transverse distribution at the longitudinal center of the septum magnet was measured with a circular search coil of which mean diameter is 6.5 mm with 500. *units?*

"cancelled"
format

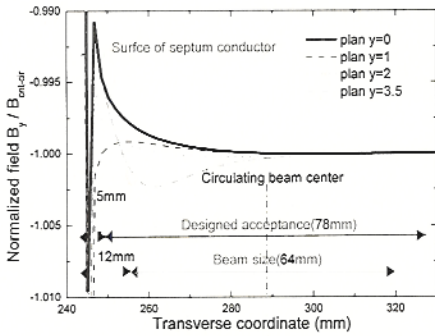

Fig.6 The transverse magnetic field distribution in the circulating beam side

The measured results are in accord with the calculations well inside septum and the field distribution is within the tolerance

of $\pm 0.5\%$

B. Longitudinal distribution of B_y (Vertical component)

The B_y longitudinal distribution at the circulating beam center was measured with a same search coil as the measurements of the transverse distribution. Fig. 7 is a comparison of the measured data and the calculation data [2]. The calculation agrees with the measured data. The gaps of the sub-bending magnets are adjusted so that the integral magnetic field along the circulating beam axis to be zero to suppress the closed orbit distortion. The error field is checked by numerical integration and direct measurement of integral magnetic field by long parallel search coil.

C. Transverse distribution of integral magnetic field along the beam axis

Two long search coils are used for the integral field measurement along the beam axis. One was placed at injection side as a reference, another was used to measure the transverse distribution of the integral field of B_y at the circulating beam side. Fig. 8 shows the transverse distribution of integral magnetic field of B_y along the circulating beam axis. After the sub-bending magnet gap is adjusted to 120 mm+ 9.5mm, the integral field at the circulating beam center was about 0.05 % of that at the injection side. The estimated miss-kick angle for circulating beam is 3.4×10^{-2} mrad. In this case, the maximum closed orbit distortion is estimated to be 0.5 mm.

The quadrupole component is also able to be compensated by small tilting of pole face of sub-bending magnet.

VI. MODULATION OF THE BETA-FUNCTION BY A "DOG-LEG" BUMP ORBIT

The opposite-field septum magnet system inevitably forms a "Dog-leg" bump orbit at the circulating beam side. Vertical edge focusing is accumulated irrespective of a reversal of the polarity of the magnets.

β modulation by integrated edge focusing in the vertical plane has been carefully examined by an orbit analysis using a simulation code. The increment of the beam aperture is 2%, which is within the tolerance of the design of the beam optics.

" β -function"

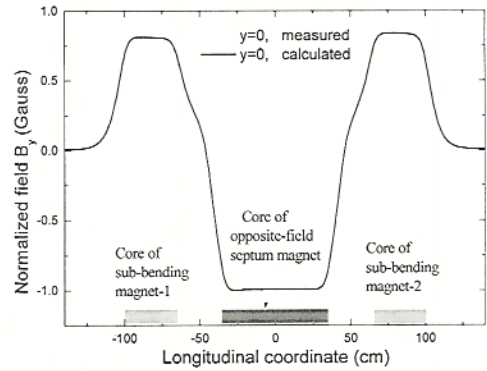

Fig. 7 Longitudinal distribution of B_y along the center of circulating beam axis

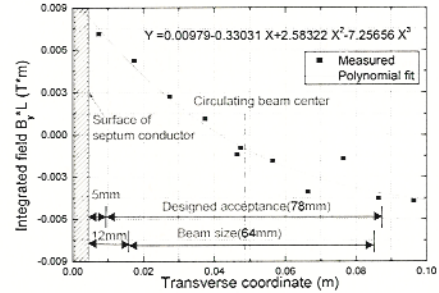

Fig. 8 Transverse distribution of integral magnetic field of B_y

VII. SUMMARY

The opposite-field type septum magnet combined with sub-bending magnets has unique features compared with normal septum magnets as a force-free structure, and cancellation of the leakage flux at the septum. The force-free structure and easy pulse-excitation permits thin septum magnets with a high magnetic field. There is some possibility to solve difficult problems concerning fast extraction and injection of high-energy synchrotrons.

The key technology is how to suppress the error fields of the circulating beam side caused by fabrication errors and eddy currents by pulse excitation.

In the case of the injection septum magnet for the J-PARC 50-GeV proton synchrotron, a larger beam aperture than the full acceptance of the ring can be obtained for low-loss injection. Also, a force-free structure enables only the septum conductor to be set inside of the vacuum for a low evacuating load. This method is applicable to injection / fast extraction septum magnets for many kinds of accelerators.

"force free"

REFERENCES

- [1] I.Sakai, et. al., "Opposite field septum magnet system for the separation of charged particle beams", IEEE Trans. on Applied Supercon., Vol.12, No.1, March 2002. pp. 242-246
- [2] K.Fan, et.al, "3-D Calculations and Measurements of the Opposite Field Septum Magnet for the J-PARC 50GeV Ring", Proceedings of the 2nd annual meeting of particle accelerator society of japan and the 30th linear accelerator meeting in Japan

"cap"

